

Guide to Harmonics with AC Drives



Contents

1.	Introduction	5
2.	Basics of the harmonics phenomena	6
3.	Harmonic distortion sources and effects	8
4.	Harmonic distortion calculation by using DriveSize software	9
4.1	Circuit diagram for the calculation example	9
4.2	Input data for motor load	9
4.3	Motor selection	10
4.4	Inverter selection	10
4.5	Inverter supply unit data	10
4.6	Network and Transformer data input	10
4.7	Calculated harmonic current and voltage	11
4.8	Calculated harmonic currents in graphical form ...	11
4.9	Part of the printed report	11
5.	Standards for harmonic limits	12
5.1	EN61800-3 (IEC1800-3) Adjustable speed electrical power drive systems	12
5.2	IEC1000-2-2, Electromagnetic compatibility (EMC)	13
5.3	IEC1000-2-4, Electromagnetic compatibility (EMC)	13
5.4	IEC1000-3-2, Electromagnetic compatibility (EMC)	13
5.5	IEC1000-3-4, Electromagnetic compatibility (EMC)	13
5.6	IEEE519, IEEE Recommended practices and requirements for harmonic control in electrical power systems	14
6.	Evaluating harmonics	16
7.	How to reduce harmonics by structural modifications in the AC drive system	17
7.1	Factors in the AC drive having an effect on harmonics	17
7.2	Table: List of the different factors and their effects	18
7.3	Using 6-pulse diode rectifier	18
7.4	Using 12-pulse or 24-pulse diode rectifier	19

7.5	Using phase controlled thyristor rectifier	19
7.6	Using IGBT bridge	20
7.7	Using larger DC or AC inductor	21
8.	Other methods for harmonics reduction	24
8.1	Tuned single arm passive filter	24
8.2	Tuned multiple arm passive filter	24
8.3	External active filter	25
9.	Summary of harmonics attenuation	26
9.1	6-pulse rectifier without inductor	26
9.2	6-pulse rectifier with inductor	26
9.3	12-pulse rectifier with polycon transformer	26
9.4	12-pulse with double wound transformer	26
9.5	24-pulse rectifier	26
9.6	Active IGBT rectifier	27
10.	Definitions	28
11.	Index	30

Chapter 1 - Introduction

General

This guide continues ABB's technical guide series, describing harmonic distortion, its sources and effects, and also distortion calculation and evaluation. Special attention has been given to the methods for reducing harmonics with AC drives.

Chapter 2 - Basics of the harmonics phenomena

Harmonic currents and voltages are created by non-linear loads connected on the power distribution system. Harmonic distortion is a form of pollution in the electric plant that can cause problems if the sum of the harmonic currents increases above certain limits.

All power electronic converters used in different types of electronic systems can increase harmonic disturbances by injecting harmonic currents directly into the grid. Figure 2.1 shows how the current harmonics (i_h) in the input current (i_s) of a power electronic converter affect the supply voltage (u_t).

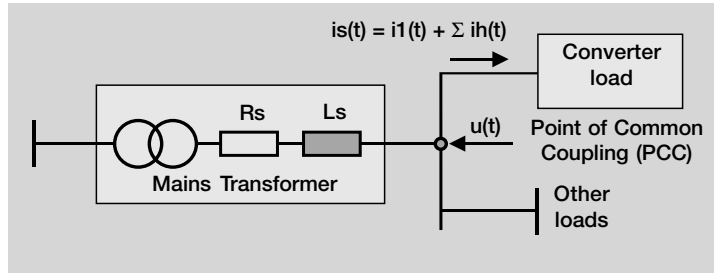

Figure 2.1 Plant with converter load, mains transformer and other loads.

The line current of a 3-phase, 6-pulse rectifier can be calculated from the direct output current by using the following formula.

$$I_1' = \sqrt{\frac{2}{3}} * I_d \text{ , where}$$

I_1' = the total RMS current and

I_d = direct current output from the rectifier.
(valid for ideal filtered DC current)

The fundamental current is then

$$I_1 = I_1' * \frac{3}{\pi}$$

In a theoretical case where output current can be estimated as clean DC current, the harmonic current frequencies of a 6-pulse three phase rectifier are n times the fundamental frequency (50 or 60 Hz). The information given below is valid in the case when the line inductance is insignificant compared to the DC reactor inductance. The line current is then rectangular with 120° blocks. The order numbers n are calculated from the formula below:

$$n = 6k \pm 1, \text{ where } k = 1, 2, 3, \dots$$

The rms values of the harmonic components are:

$$I_{ni} = \frac{I_1}{n}$$

and the harmonic components are as shown in Figure 2.2.

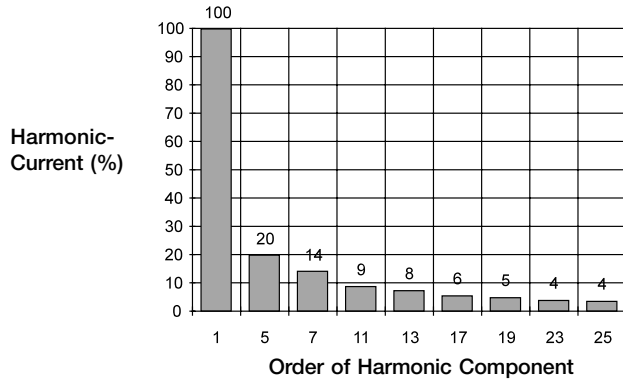

Figure 2.2 The harmonic content in a theoretical rectangular current of a 6-pulse rectifier.

The principle of how the harmonic components are added to the fundamental current is shown in Figure 2.3, where only the 5th harmonic is shown.

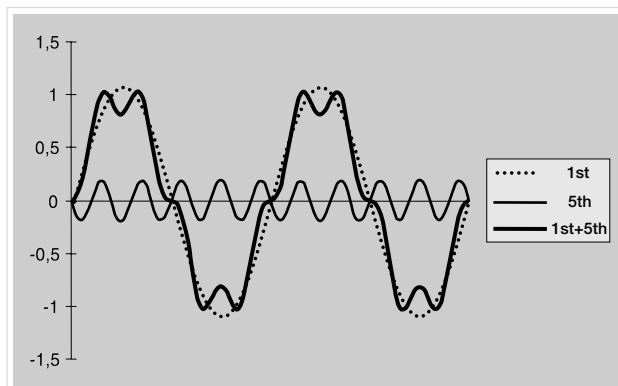

Figure 2.3 The total current as the sum of the fundamental and 5th harmonic.

Chapter 3 - Harmonic distortion sources and effects

Common non-linear loads include motor starters, variable speed drives, computers and other electronic devices, electronic lighting, welding supplies and uninterrupted power supplies.

The effects of harmonics can be overheating of transformers, cables, motors, generators and capacitors connected to the same power supply with the devices generating the harmonics. Electronic displays and lighting may flicker, circuit breakers can trip, computers may fail and metering can give false readings.

If the cause of the above mentioned symptoms is not known, then there is cause to investigate the harmonic distortion of the electricity distribution at the plant. The effects are likely to show up in the customer's plant before they show on the utility system. This Technical Guide has been published to help customers to understand the possible harmonic problems and make sure the harmonic distortion levels are not excessive.

Chapter 4 - Harmonic distortion calculation by using DriveSize software

The harmonic currents cause a distortion of the line voltage. In principle the voltage harmonics can be calculated at any point of the network if the harmonic currents and the corresponding source impedance are known. The circuit diagrams in Figure 4.1. show the network supplying the converter and the other essential parts of the installation. ABB DriveSize software is used for the calculation example.

4.1 Circuit diagram for the calculation example

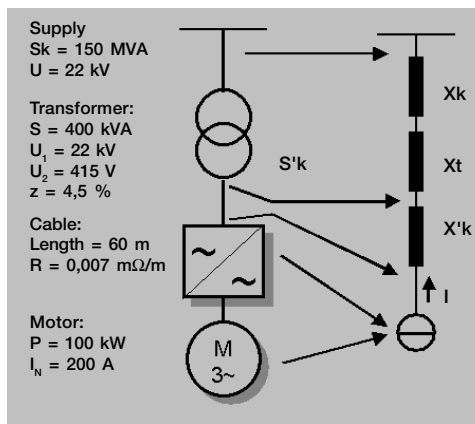

Figure 4.1. Network supplying a frequency converter in the middle and its equivalent diagram on the right. The data for this example is on the left.

4.2 Input data for motor load

Motor load			
Load type	Const. torque/power		
Overload type	One overload		
	min	base	max
Speed [rpm]	0	1450	1500
Power [kW]	0	100	100
Overload [%]		100	100
Overload time [s]	60	every [s]	600

Figure 4.2. The most important motor load data for harmonics calculation is the base power in kW.

4.3 Motor selection

Selected motor data M2BA 315 SMC 6	
Selection	DriveSize
Voltage [V]	415
Connection	D
Frequency [Hz]	50
Power [kW]	110
Poles	6
Speed [rpm]	992
Max mech. speed [rpm]	2300
Current [A]	197
Torque [Nm]	1060
T max/Tn	3,2
Power factor	0,82
Efficiency [%]	95,6
Insulation class	F

Figure 4. 3. The software makes the motor selection for the defined load. If required there is an option to select a different motor than that selected by the DriveSize.

4.4 Inverter selection

Selected inverter data ACS607-0140-3	
Selection	User
Selection method	Current (normal)
Voltage [V]	400
Drive power [kVA]	140
Pn [kW]	110
Normal Icont [A]	216
Normal Imax [A]	238
Phd [kW]	90
Heavyduty Icont [A]	178
Heavyduty Imax [A]	267
Pulse	6
Frame type	R8
P&F 12Nsq [A]	260

4.4. The inverter selection is based on the previous motor selection and here also the user has an option to select the inverter manually.

4.5 Inverter supply unit data

Supply unit data	
Pulse #	6
Lv [μ H]	110
Cdc [mF]	4,95
Udc [V]	560
Idc [A]	191

Figure 4.5. The supply unit data is defined by DriveSize according to the inverter type selected.

4.6 Network and Transformer data input

Network and Transformer data			
Primary voltage [V]	22000	Secondary voltage [V]	415
Frequency [Hz]	50		
Network Sk [MVA]	150	<input type="checkbox"/> unknow	
Transformer Sn [kVA]	400		
Transformer Pk [kW]	3,0		
Transformer Zk [%]	3,8		
Supply cable type	<input checked="" type="radio"/> Cable <input type="radio"/> Busbar		
Cable quantity	3	Impedance [$\mu\Omega$]	70
Cable lenght [m]	60		

Figure 4.6. The network and transformer data input is given here. For standard ABB transformers the data is shown automatically.

4.7 Calculated harmonic current and voltage

THD		Current	Voltage	n	f [Hz]	Current [A]	In/I1	Voltage [V]
Result	47,1%	0,2%		1	50	2,8	100,0 %	21996,6
IEEE Calc	0,2%/	0,2%/		5	250	1,2	41,2 %	32,9
IEEE Limit	15,0%	0,5%		7	350	0,6	19,5 %	21,7
				11	550	0,2	8,6 %	15,1
				13	650	0,2	5,6 %	11,7
				17	850	0,1	4,2 %	11,3
				19	950	0,1	2,7 %	8,1
				23	1150	0,1	2,3 %	8,2
				25	1250	0,0	1,4 %	5,5
				29	1450	0,0	1,2 %	5,3
				31	1550	0,0	0,8 %	3,7
				35	1750	0,0	0,5 %	3,0
				37	1850	0,0	0,6 %	3,3

Figure 4.7. The harmonics are calculated by making discrete Fourier transformation to the simulated phase current of the incoming unit. Different kinds of circuit models are used, one for SingleDrive with AC inductors and one for diode and thyristor supply with DC inductors. There are also models for 6, 12 and 24 pulse connections.

4.8 Calculated harmonic currents in graphical form

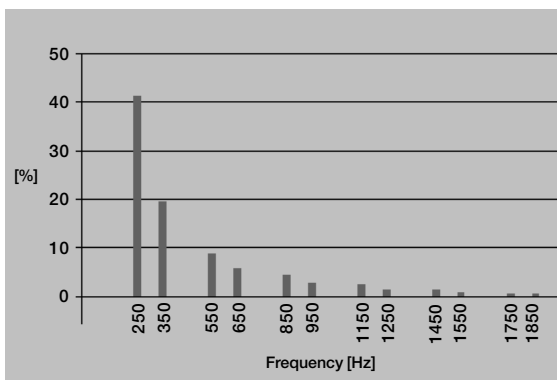

Figure 4.8. The results of calculations can be shown in table form as above or as a graph.

4.9 Part of the printed report

ABB					
Network check		ACS607-0140-3			
Network and Transformer data		Supply unit data			
Normal voltage [V]	22000 (primary side)	Pulse #	6		
Frequency [Hz]	50	Lv [µH]	110		
Network Sk [MVA]	150	Cdc [mF]	4,95		
Transformer Sn [kVA]	400	Udc [V]	560		
Transformer Pk [kW]	3,0	Idc [A]	191		
Transformer Zk [%]	3,8				
Supply cable type	Cable				
Cable quantity	3				
Cable length	60				
Result				IEEE 519 limits	calc/limit
Cosφii	0,999	THD Current	47,1 %	THD Current	0,2 %/15,0 %
Tot. power factor	0,90	THD Voltage	0,2 %	THD Voltage	0,2 %/5,0 %
Unmax mot.	98 %				

Figure 4.9. The input data and calculated results can be printed out as a report, which is partly shown here.

Chapter 5 - Standards for harmonic limits

The most common international and national standards setting limits on harmonics are described below.

Figure 5.1 is shown as an example for harmonic distortion limits.

5.1 EN61800-3 (IEC1800-3) Adjustable speed electrical power drive systems

Part 3: EMC product standard including specific test methods

The countries of the European Economic Area (EEA) have agreed on common minimum regulatory requirements in order to ensure the free movement of products within the EEA. The CE marking indicates that the product works in conformity with the directives that are valid for the product. The directives state the principles that must be followed. Standards specify the requirements that must be met. EN61800-3 is the EMC product standard of adjustable speed electrical power drive systems (PDS). Meeting the requirements of this standard, is the minimum condition for free trade of power electronics converters inside the EEA.

EN61800-3 states, that the manufacturer shall provide in the documentation of the PDS, or on request, the current harmonic level, under rated conditions, as a percentage of the rated fundamental current on the power port. The referenced values shall be calculated for each order at least up to the 25th. The current THD (orders up to and including 40), and its high-frequency component PHD (orders from 14 to 40 inclusive) shall be evaluated. For these standard calculations, the PDS shall be assumed to be connected to a PC with $R_{sc} = 250$ and with initial voltage distortion less than 1%. The internal impedance of the network shall be assumed to be a pure reactance.

In a low voltage public supply network, the limits and requirements of IEC1000-3-2 apply for equipment with rated current ≤ 16 A. The use of the future IEC1000-3-4 is recommended for equipment with rated current > 16 A.

If PDS is used in an industrial installation, a reasonable economical approach, which considers the total installation, shall be used. This approach is based on the agreed power, which the supply can deliver at any time. The method for calculating the harmonics of the total installation is agreed and the limits for either the voltage distortion or the total harmonic current emission are agreed on. The compatibility limits given in IEC1000-2-4 may be used as the limits of voltage distortion.

5.2
IEC1000-2-2,
Electromagnetic
compatibility
(EMC)

Part 2: Environment - Section 2: Compatibility levels for low frequency conducted disturbances and signalling in public low-voltage power supply systems

This standard sets the compatibility limits for low-frequency conducted disturbances and signalling in **public low-voltage power supply** systems. The disturbance phenomena include harmonics, inter-harmonics, voltage fluctuations, voltage dips and short interruptions voltage imbalance and so on. Basically this standard sets the design criteria for the equipment manufacturer, and amounts to the minimum immunity requirements of the equipment. IEC1000-2-2 is in line with the limits set in EN50160 for the quality of the voltage the utility owner must provide at the customer's supply-terminals.

5.3
IEC1000-2-4,
Electromagnetic
compatibility
(EMC)

Part 2: Environment - Section 4: Compatibility levels in industrial plants for low frequency conducted disturbances

IEC1000-2-4 is similar to IEC1000-2-2, but it gives compatibility levels **for industrial and non-public networks**. It covers low-voltage networks as well as medium voltage supplies excluding the networks for ships, aircraft, offshore platforms and railways.

5.4
IEC1000-3-2,
Electromagnetic
compatibility
(EMC)

Part 3: Limits - Section 2: Limits for harmonic current emissions (equipment current <16 A per phase

This standard deals with the harmonic current emission limits of individual equipment connected to **public networks**. The date of implementation of this standard is January 1st 2001, but there is extensive work going on at the moment to revise the standard before this date. The two main reasons for the revision are the need for the standard to cover also the voltage below 230 V and the difficulties and contradictions in applying the categorisation of the equipment given in the standard.

5.5
IEC1000-3-4,
Electromagnetic
compatibility
(EMC)

This standard has been published as a Type II Technical report. Work is going on to convert it into a standard. It gives the harmonic current emission limits for individual equipment having a rated current of more than 16 A up to 75 A. It applies to public networks having nominal voltages from 230 V single phase to 600 V three phase.

The standard gives three different stages for connection procedures of the equipment. Meeting the individual harmonic limits of Stage 1 allows the connection of the equipment at any point in the supply system. Stage 2 gives individual harmonic current limits as well as THD and its weighted high frequency counterpart PWhd. The limits are classified and tabulated by the short circuit ratio. The third stage of connection is based on an agreement between the user and the supply authority, based on the agreed active power of the consumer's installation. If the rated current is above 75 A, Stage 3 applies in any case.

The structure of this standard is generally seen to be good, but it may justly be questioned whether single and three-phase equipment should have different limits in Stage 2. It is very probable that the structure of the standard will remain as it is, but the version having the status of actual standard, will contain different limits for single and three-phase equipment.

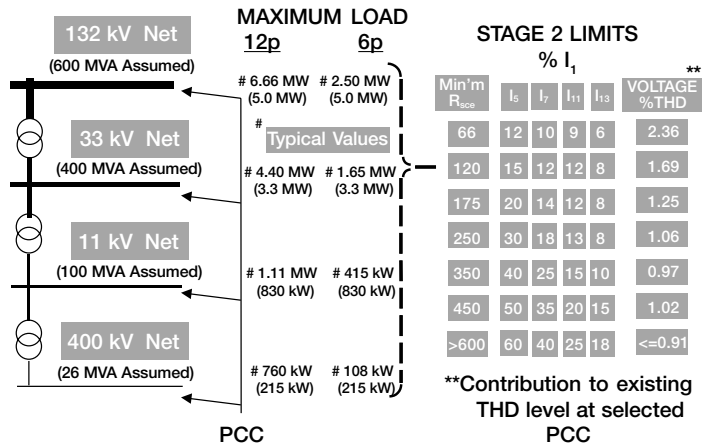

Figure 5.1 Limits on Harmonics in the proposed EN61000-3-4.

5.6 IEEE519, IEEE Recommended practices and requirements for harmonic control in electrical power systems

The philosophy of developing harmonic limits in this recommended practice is to limit the harmonic injection from individual customers so that they will not cause unacceptable voltage distortion levels for normal system characteristics and to limit overall harmonic distortion of the system voltage supplied by the utility. This standard is also recognised as American National Standard and it is widely used in the USA, especially in the municipal public works market.

The standard does not give limits for individual equipment, but for individual customers. The customers are categorised by the ratio of available short circuit current (I_{sc}) to their maximum demand load current (I_L) at the point of common coupling. The total demand load current is the sum of both linear and non-linear loads. Within an industrial plant, the PCC is clearly defined as the point between the non-linear load and other loads.

The allowed individual harmonic currents and total harmonic distortion are tabulated by the ratio of available short circuit current to the total demand load current (I_{sc}/I_L) at the point of common coupling. The limits are as a percentage of I_L for all odd and even harmonics from 2 to infinity. Total harmonic distortion is called total demand distortion and also it should be calculated up to infinity. Many authors limit the calculation of both the individual components and TDD to 50.

The table 10.3 of the standard is sometimes misinterpreted to give limits for the harmonic emissions of a single apparatus by using R_{sc} of the equipment instead of I_{sc}/I_L of the whole installation. The limits of the table should not be used this way, since the ratio of the short circuit current to the total demand load current of an installation should always be used.

Chapter 6 - Evaluating harmonics

The "Guide for Applying Harmonic Limits on Power Systems" P519A/D6 Jan 1999 introduces some general rules for evaluating harmonic limits at an industrial facility. The procedure is shown in the flowchart in Figure 6.1.

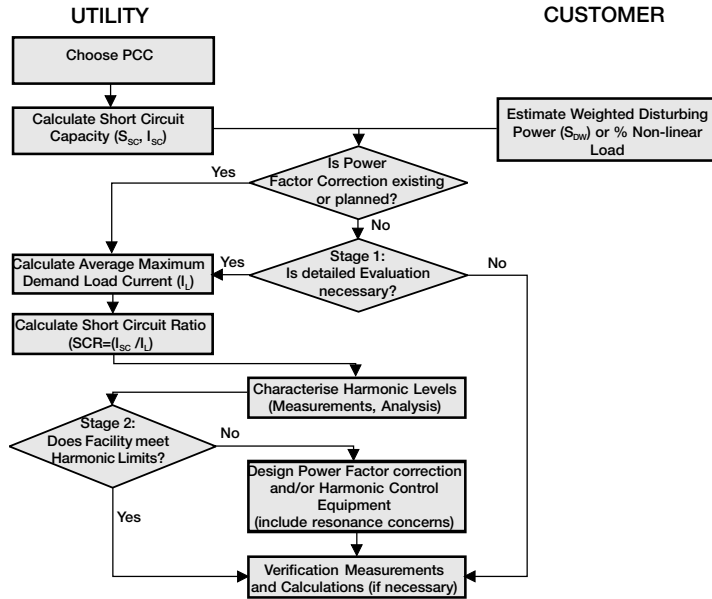

Figure 6.1 Evaluation of harmonic distortion.

Chapter 7 - How to reduce harmonics by structural modifications in the AC drive system

Harmonics reduction can be done either by structural modifications in the drive system or by using external filtering. The structural modifications can be to strengthen the supply, to use 12 or more pulse drive, to use a controlled rectifier or to improve the internal filtering in the drive.

7.1 Factors in the AC drive having an effect on harmonics

Figure 7.1 shows the factors in the AC drive system which have some influence on harmonics. The current harmonics depend on the drive construction and the voltage harmonics are the current harmonics multiplied by the supply impedances.

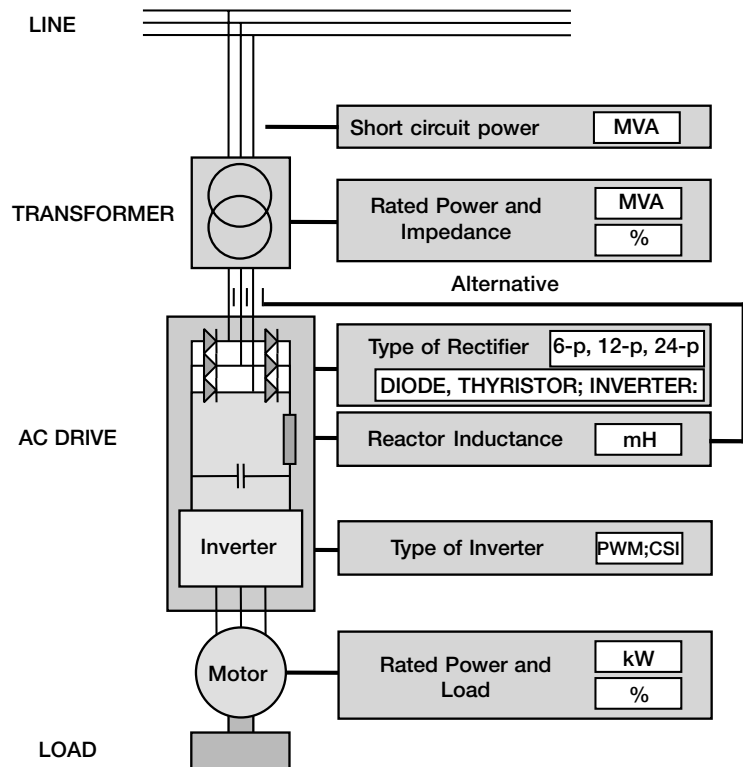

Figure 7.1 Drive system features affecting harmonics.

**7.2 Table:
List of the
different
factors and
their effects**

The cause	The effect
The larger the motor...	the higher the current harmonics
The higher the motor load...	the higher the current harmonics
The larger the DC or AC inductance...	the lower the current harmonics
The higher the number of pulses in the rectifier...	the lower the current harmonics
The larger the transformer...	the lower the voltage harmonics
The lower the transformer impedance...	the lower the voltage harmonics
The higher the short circuit capacity of supply...	the lower the voltage harmonics

**7.3 Using
6-pulse diode
rectifier**

The connections for different rectifier solutions are shown in Figure 7.2. The most common rectifier circuit in 3-phase AC drives is a 6-pulse diode bridge. It consists of six uncontrollable rectifiers or diodes and an inductor, which together with a DC-capacitor forms a low-pass filter for smoothing the DC-current. The inductor can be on the DC- or AC-side or it can be left totally out. The 6-pulse rectifier is simple and cheap but it generates a high amount of low order harmonics 5th, 7th, 11th especially with small smoothing inductance.

The current form is shown in Figure 7.2. If the major part of the load consists of converters with a 6-pulse rectifier, the supply transformer needs to be oversized and meeting the requirements in standards may be difficult. Often some harmonics filtering is needed.

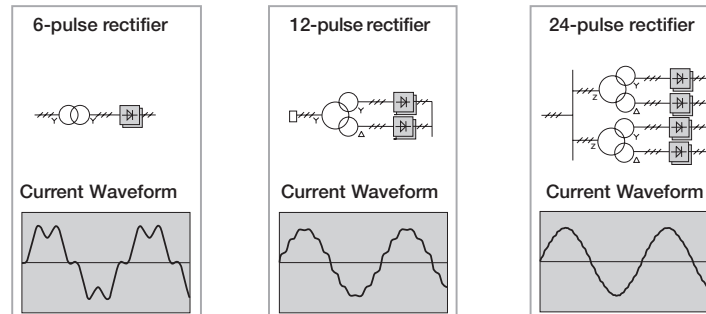

Figure 7.2 Harmonics in line current with different rectifier constructions.

7.4 Using 12-pulse or 24-pulse diode rectifier

The 12-pulse rectifier is formed by connecting two 6-pulse rectifiers in parallel to feed a common DC-bus. The input to the rectifiers is provided with one three-winding transformer. The transformer secondaries are in 30 ° phase shift. The benefit with this arrangement is that in the supply side some of the harmonics are in opposite phase and thus eliminated. In theory the harmonic component with the lowest frequency seen at the primary of the transformer is the 11th.

The major drawbacks are special transformers and a higher cost than with the 6-pulse rectifier.

The principle of the 24-pulse rectifier is also shown in Figure 7.2. It has two 12-pulse rectifiers in parallel with two three-winding transformers having 15 ° phase shift. The benefit is that practically all low frequency harmonics are eliminated but the drawback is the high cost. In the case of a high power single drive or large multidrive installation a 24-pulse system may be the most economical solution with lowest harmonic distortion.

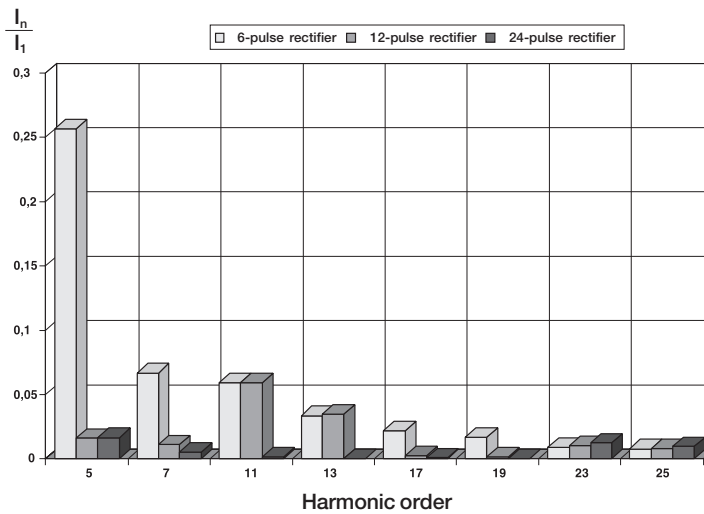

Figure 7.3 Harmonic components with different rectifiers.

7.5 Using phase controlled thyristor rectifier

A phase controlled rectifier is accomplished by replacing the diodes in a 6-pulse rectifier with thyristors. Since a thyristor needs a triggering pulse for transition from nonconducting to conducting state, the phase angle at which the thyristor starts to conduct can be delayed. By delaying the firing angle over 90 °, the DC-bus voltage goes negative. This allows regenerative flow of power from the DC-bus back to the power supply.

Standard DC-bus and inverter configurations do not allow polarity change of the DC-voltage and it is more common to connect another thyristor bridge anti-parallel with the first one to allow the current polarity reversal. In this configuration the first bridge conducts in rectifying mode and the other in regenerating mode.

The current waveforms of phase controlled rectifiers are similar to those of the 6-pulse diode rectifier, but since they draw power with an alternating displacement power factor, the total power factor with partial load is quite poor. The poor power factor causes high apparent current and the absolute harmonic currents are higher than those with a diode rectifier.

In addition to these problems, phase-controlled converters cause commutation notches in the utility voltage waveform. The angular position of the notches varies along with the firing angle.

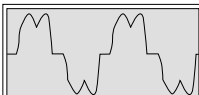
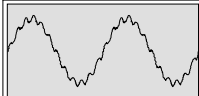
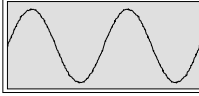
Supply type	Current TDH (%)	Voltage TDH (%) RSC=20	Voltage TDH (%) RSC=100	Current Waveform
6-pulse rectifier	30	10	2	
12-pulse rectifier	10	6	1.2	
IGBT Supply Unit	4	8	1.8	

Distortion is in % of RMS values

Figure 7.4 Distortion of different supply unit types. Values may vary case by case.

7.6 Using IGBT bridge

Introducing a rectifier bridge, made of self commutated components, brings several benefits and opportunities compared to phase commutated ones. Like a phase commutated rectifier, this hardware allows both rectification and regeneration, but it makes it possible to control the DC-voltage level and displacement power factor separately regardless of the power flow direction.

The main benefits are:

- Safe function in case of mains supply disappearance.
- High dynamics of the drive control even in the field weakening range.

- Possibility to generate reactive power.
- Nearly sinusoidal supply current with low harmonic content. Measured results for one drive is shown in Figure 7.5. When comparing with Figure 7.3 we can see a clear difference. IGBT has very low harmonics at lower frequencies, but somewhat higher at higher frequencies.
- Voltage boost capability. In case of low supply voltage the DC voltage can be boosted to keep motor voltage higher than supply voltage.

The main drawback is the high cost coming from the IGBT bridge and extra filtering needed.

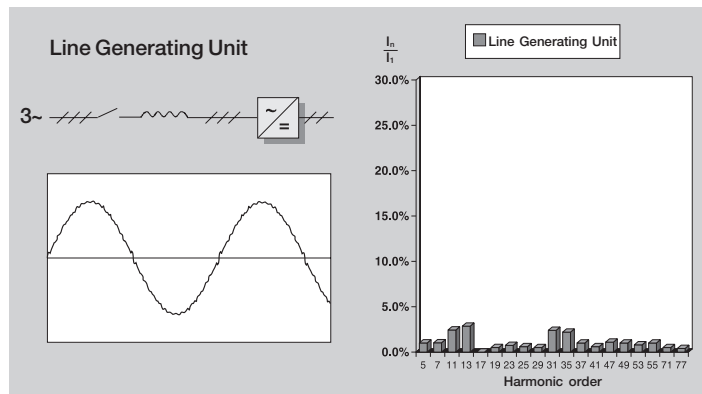

Figure 7.5 Harmonics in line current IGBT line generating unit.

7.7 Using a larger DC or AC inductor

The harmonics of a voltage source AC drive can be significantly reduced by connecting a large enough inductor in its AC input or DC bus. The trend has been to reduce the size of converter while the inductor size has been also reduced, or in several cases it has been omitted totally. The effect of this can be seen from the curve forms in Figure 7.6.

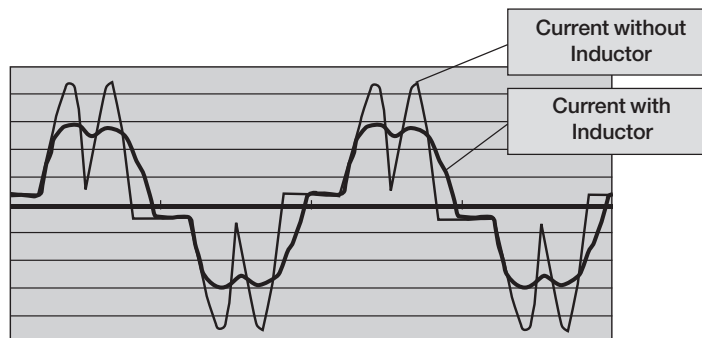

Figure 7.6 The effect of the inductor on the line current.

The chart in Figure 7.7 shows the effect of the size of the DC inductor on the harmonics. For the first 25 harmonic components the theoretical THD minimum is 29%. That value is practically reached when the inductance is 100 mH divided by the motor kW or 1 mH for a 100 kW motor (415 V, 50 Hz). Practically sensible is about 25 mH divided by motor kW, which gives a THD of about 45%. This is 0,25 mH for a 100 kW motor.

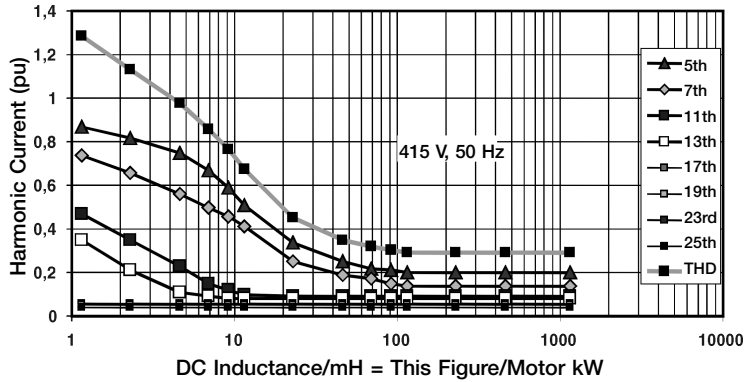

Figure 7.7 Harmonic current as function of DC inductance.

The voltage distortion with certain current distortion depends on the Short Circuit Ratio R_{sc} of the supply. The higher the ratio, the lower the voltage distortion. This can be seen in Figure 7.8.

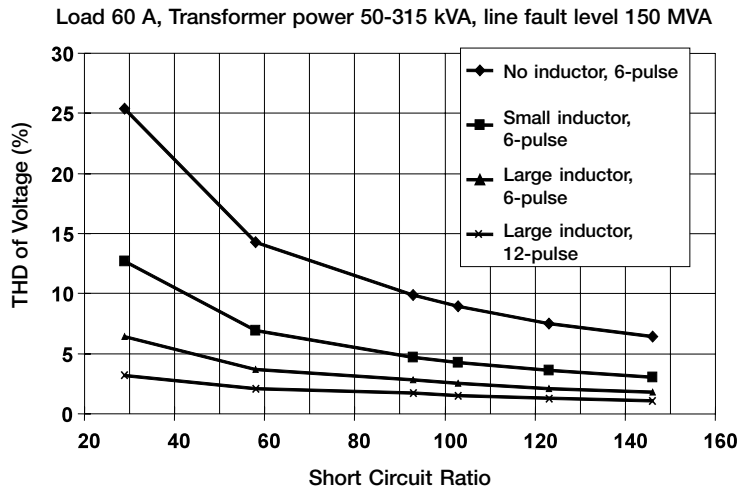

Figure 7.8 THD Voltage vs Type of AC drive and transformer size.

Figure 7.9 introduces a simple nomogram for estimation of harmonic voltages. On the graph below right select first the motor kilowatt, then the transformer kVA and then move horizontally to the diagonal line where you move upwards and stop at the curve valid for your application. Then turn left to the y-axis and read the total harmonic voltage distortion.

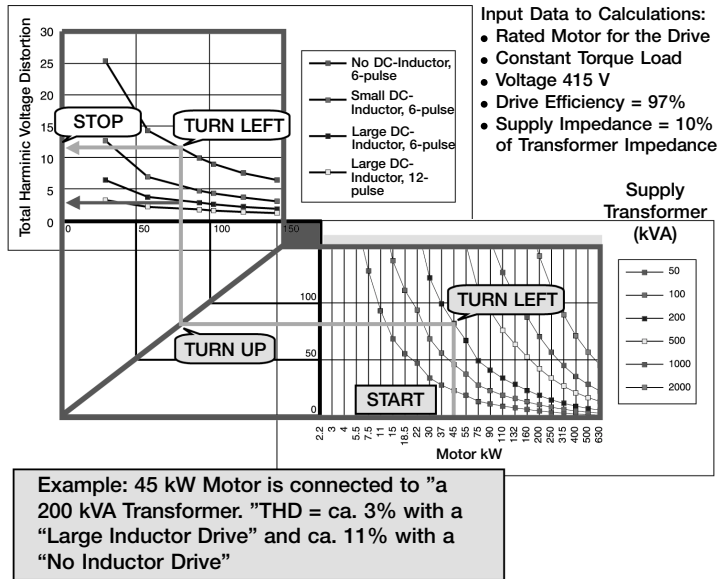

Figure 7.9 Total harmonic distortion nomogram.

Results from laboratory tests with drive units from different manufacturers are shown in Figure 7.10. Drive A with large DC inductor has the lowest harmonic current distortion, drives with no inductor installed have the highest distortion.

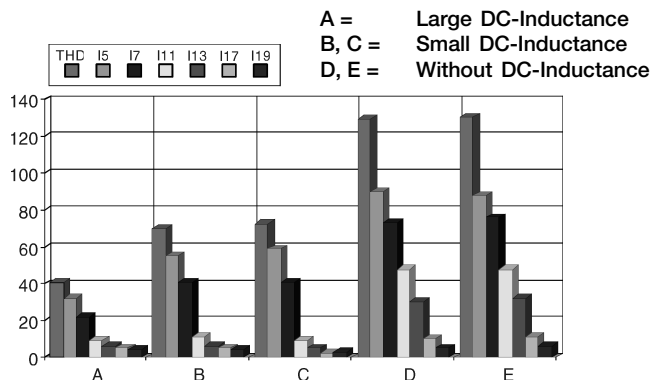

Figure 7.10. Harmonic current with different DC-Inductances.

Chapter 8 - Other methods for harmonics reduction

Filtering is a method to reduce harmonics in an industrial plant when the harmonic distortion has been gradually increased or as a total solution in a new plant. There are two basic methods: passive and active filters.

8.1 Tuned single arm passive filter

The principle of a tuned arm passive filter is shown in Figure 8.1. A tuned arm passive filter should be applied at the single lowest harmonic component where there is significant harmonic generation in the system. For systems that mostly supply an industrial load this would probably be the fifth harmonic. Above the tuned frequency the harmonics are absorbed but below that frequency they may be amplified.

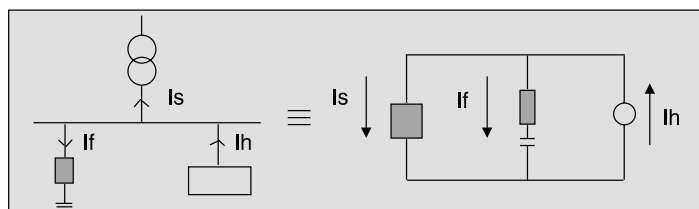

- Detuned - Single tuning frequency
- Above tuned frequency harmonics absorbed
- Below tuned frequency harmonics may be amplified
- Harmonic reduction limited by possible over compensation at the supply frequency and network itself

Figure 8.1 Tuned single arm passive filter.

This kind of filter consists of an inductor in series with a capacitor bank and the best location for the passive filter is close to the harmonic generating loads. This solution is not normally used for new installations.

8.2 Tuned multiple arm passive filter

The principle of this filter is shown in Figure 8.2. This filter has several arms tuned to two or more of the harmonic components which should be the lowest significant harmonic frequencies in the system. The multiple filter has better harmonic absorption than the one arm system.

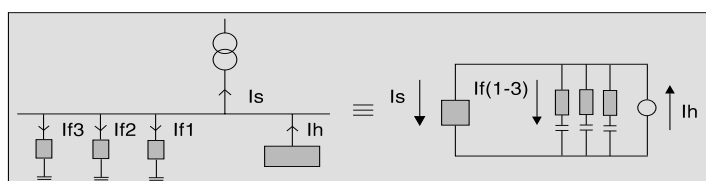

- Capacitive below tuned frequency/Inductive above
- Better harmonic absorption
- Design consideration to amplification harmonics by filter
- Limited by KVAR and network

Figure 8.2 Tuned multiple arm passive filter.

8.3 External active filter

The multiple arm passive filters are often used for large DC drive installations where a dedicated transformer is supplying the whole installation.

A passive tuned filter introduces new resonances that can cause additional harmonic problems. New power electronics technologies are resulting in products that can control harmonic distortion with active control. These active filters, see Figure 8.3, provide compensation for harmonic components on the utility system based on existing harmonic generation at any given moment in time.

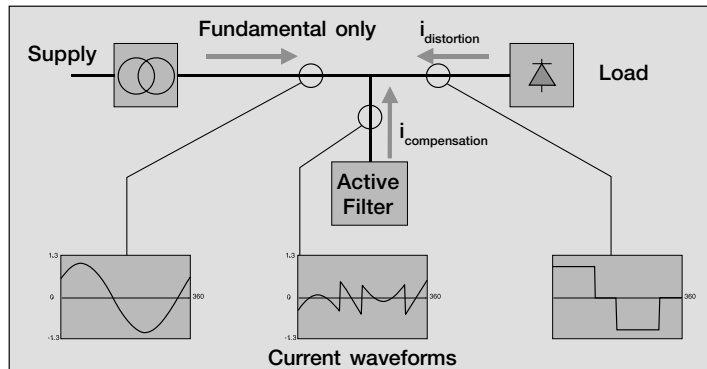

Figure 8.3 External active filter principle diagram.

The active filter compensates the harmonics generated by nonlinear loads by generating the same harmonic components in opposite phase as shown in Figure 8.4. External active filters are most suited to multiple small drives. They are relatively expensive compared to other methods.

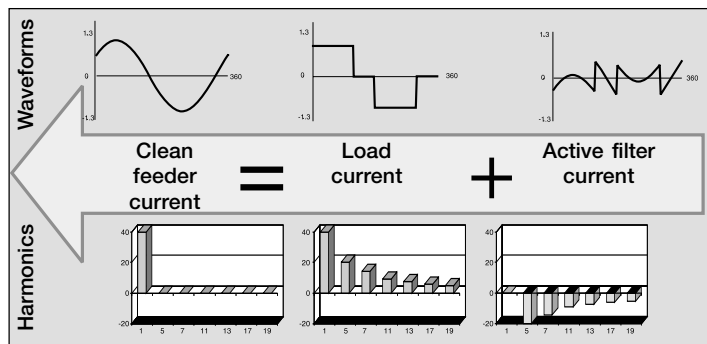

Figure 8.4 External active filter waveforms and harmonics.

Chapter 9 - Summary of harmonics attenuation

There are many options to attenuate harmonics either inside the drive system or externally. They all have advantages and disadvantages and all of them show cost implications. The best solution will depend on the total loading, the supply to the site and the standing distortion.

In the following tables different internal actions are compared to the basic system without inductor. The harmonic content is given with 100% load. The costs are valid for small drives. For multidrive the 12-pulse solution is quite a lot cheaper.

9.1 6-pulse rectifier without inductor

Manufacturing cost 100%
Typical harmonic current components.

Fundamental	5 th	7 th	11 th	13 th	17 th	19 th
100%	63%	54%	10%	6,1%	6,7%	4,8%

9.2 6-pulse rectifier with inductor

Manufacturing cost 120%. AC or DC choke added
Typical harmonic current components.

Fundamental	5 th	7 th	11 th	13 th	17 th	19 th
100%	30%	12%	8,9%	5,6%	4,4%	4,1%

9.3 12-pulse rectifier with polycon transformer

Manufacturing cost 200%
Typical harmonic current components.

Fundamental	5 th	7 th	11 th	13 th	17 th	19 th
100%	11%	5,8%	6,2%	4,7%	1,7%	1,4%

9.4 12-pulse with double wound transformer

Manufacturing cost 210%
Typical harmonic current components.

Fundamental	5 th	7 th	11 th	13 th	17 th	19 th
100%	3,6%	2,6%	7,5%	5,2%	1,2%	1,3%

9.5 24-pulse rectifier with 2 3-winding transformers

Manufacturing cost 250%
Typical harmonic current components.

Fundamental	5 th	7 th	11 th	13 th	17 th	19 th
100%	4,0%	2,7%	1,0%	0,7%	1,4%	1,4%

**9.6 Active IGBT
rectifier**

Manufacturing cost 250%. Not significant if electrical braking is anyway needed.

Typical harmonic current components.

Fundamental	5 th	7 th	11 th	13 th	17 th	19 th
100%	2,6%	3,4%	3,0%	0,1%	2,1%	2,2%

Chapter 10 - Definitions

- S:** Apparent power
- P:** Active power
- Q:** Reactive power
- Rsc:** Short circuit ratio is defined as the short circuit power of the supply at PCC to the nominal apparent power of the equipment under consideration.
 $Rsc = S_s / S_n$.
- ω_1 :** Angular frequency of fundamental component
 $\omega_1 = 2\pi f_1$, where f_1 is fundamental frequency (eg. 50Hz or 60Hz).
- n:** Integer $n = 2, 3, \dots \infty$. Harmonic frequencies are defined as $\omega_n = n\omega_1$.
- I_n :** RMS-value of n:th harmonic component of line current.
- Z_n :** Impedance at frequency $n\omega_1$.
- %Un:** Harmonic voltage component as a percentage of fundamental (line) voltage.
- THD:** Total Harmonic Distortion in the input current is defined as:

$$THD = \frac{\sqrt{\sum_{n=2}^{\infty} I_n^2}}{I_1}$$

where I_1 is the rms value of the fundamental frequency current. The THD in voltage may be calculated in a similar way. Here is an example for the 25 lowest harmonic components with the theoretical values:

$$THD = \frac{\sqrt{20^2 + 14,3^2 + 9,1^2 + 7,7^2 + 5,9^2 + 5,3^2 + 4,4^2 + 4^2}}{100}$$
$$THD = 29\%$$

PWHD: Partial weighted harmonic distortion is defined as:

$$PWHD = \sqrt{\sum_{n=14}^{40} n \left(\frac{I_n}{I_1} \right)^2}$$

- PCC:** Point of Common Coupling is defined in this text as such a point of utility supply which may be common to the equipment in question and other equipment. There are several definitions of PCC in different standards and even more interpretations of these definitions in literature. The definition chosen here is seen as technically most sound.
- PF:** Power Factor defined as $PF = P/S$ (power / volt-ampere) = $I_1 / I_s * DPF$ (With sinusoidal current PF equals to DPF).
- DPF:** Displacement Power Factor defined as $\cos\phi_1$, where ϕ_1 is the phase angle between the fundamental frequency current drawn by the equipment and the supply voltage fundamental frequency component.

Chapter 11 - Index

3-winding 26
5th harmonic 7
6-pulse rectifier 7, 18, 19, 20
6-pulse three phase rectifier 7
12-pulse rectifier 18, 19, 20
24-pulse rectifier 18, 19

A

ABB 6, 10
AC inductor 21
active filter 5, 24, 25
active power 14, 28
American National Standard 14
anti-parallel 20
apparent power 28
attenuation 5, 26

C

calculation 5, 9, 11, 12, 15, 16, 23
CE marking 12
circuit breaker 8
common DC-bus 19
commutation notch 20
compatibility limit 12, 13
computer 8
consumer's installation 14
converter 6, 9, 12, 18, 20, 21
converter load 6

D

DC-capacitor 18
DC-current 18
displacement power factor 20, 29
distortion calculation 5, 6
distortion nomogram 23
DriveSize 9, 10, 11

E

effect 5, 6, 8, 17, 18, 21, 22
electromagnetic compatibility (EMC) 22
electronic device 8
electronic display 8
electronic lighting 8

EMC product standard 12
European Economic Area 12
evaluating of harmonic 16
external filtering 17

F

filtering 17, 18, 21, 24
frequency 9, 12, 13, 14, 19, 24, 28, 29
fundamental frequency 7, 28, 29

H

harmonic component 7, 19, 22, 24, 25, 28
harmonic currents 6, 7, 9, 11, 12, 13, 15, 20, 21, 22, 23, 26, 27
harmonic distortion 6, 8, 9, 12, 14, 15, 16, 19, 23, 25, 28
harmonic limit 12, 13, 14, 15, 16
harmonics reduction 17, 24, 25
harmonic voltage 23, 28
harmonics phenomena 6, 7

I

IGBT bridge 20, 21
inductance 17, 18, 22, 23
inductor 5, 18, 21, 22, 23, 24, 26
industrial installation 12
installation 9, 12, 14, 15, 19, 24, 25
inverter selection 10
inverter supply unit data 10

L

laboratory test 23
line current 6, 18, 21
low-pass filter 18

M

mains transformer 6
manufacturing cost 26, 27
metering 8
motor load 9
motor selection 10
motor starter 8
multiple arm passive filter 5, 24, 25

N

network 10
non-linear load 6, 8, 15, 16

O

overheating 8

P

passive filter 24, 25
phase commutated rectifier 20
PHD 12
point of common coupling 15, 29
power distribution 6
power drive system 12
power factor 16, 20, 29
power port 12
public supply 12
PWHD 14, 28

R

reactive power 21, 28
rectifier 5, 6, 7, 17, 18, 19, 20, 26, 27
rectifying mode 20
rectangular current 7
regenerating mode 20
report 11

S

short circuit power 14, 16, 17, 28
short circuit ratio 22, 28
source 6, 8, 9, 21
source impedance 4, 9
standard 12, 13, 14, 15, 18, 20, 29
structural modification 17, 18, 19, 20, 21, 22, 23
supply authority 14
supply cable 18
supply transformer 18
supply voltage 6, 21, 29

T

TDD 15
THD 12, 14, 22, 23, 28
three-winding transformer 19
thyristor 17, 19, 20
total demand distortion 15
total harmonic distortion 10, 15, 23, 28
transformer 9, 10
tuned arm passive filter 24
two-winding transformer 19

U

uninterrupted power supply 8

V

variable speed drives 8
voltage 6, 9, 11, 12, 13, 14, 17, 18, 19, 20, 21, 22, 23
voltage boost 21

W

welding supply 8



ABB Industry Oy

Drives

P. O. Box 184

FIN - 00381 Helsinki

Finland

Telephone +358 10 222 000

Telefax +358 10 222 2681

Internet <http://www.abb.com/motors&drives>

